

# **ALCOHOL DETECTION WITH ENGINE LOCKING**

*Dissertation submitted in partial fulfillment of the  
requirements for the*

*Degree Of*

**BACHELOR OF TECHNOLOGY**

**IN**

**ELECTRONICS AND COMMUNICATION  
ENGINEERING**

**BY**

**DIVESH KUMAR-151029**

**APOORV UPADHYAY-151108**

**ANSHUMAN THAKUR-151094**

**UNDER THE GUIDANCE OF**

**DR. SHWETA PANDIT**



Department of Electronics and Communication Engineering

# TABLE OF CONTENTS

	Page Number
DECLARATION BY THE SCHOLAR	iii
CERTIFICATE	iv
ACKNOWLEDEMENT	v
LIST OF FIGURES	vi
ABSTRACT	1
CHAPTER-1 INTRODUCTION	2
CHAPTER-2 COMPONENTS USED	4
2.1 ARDUINO UNO	4
2.2 HC-SR04 ULTRASONIC SENSOR	8
2.2.1 FEATURES	10
2.2.2 SPECIFICATIONS	10
2.3 MQ-3 SENSOR	11
2.4 BUZZER	13
2.5 DC MOTOR	14
2.6 SIM900A	15
2.7 LED	16
CHAPTER-3 LITERATURE SURVEY	17
CHAPTER-4 METHODOLOGY	18
4.1 ALCOHOL DETECTION WITH ENGINE LOCKING	
4.1.1 STEP BY STEP PROCESS	19
CHAPTER-5 APPLICATIONS, FURTHER DEVELOPMENTS AND CODE	20
5.1 APPLICATIONS AND ADVANTAGES	20
5.2 FURTHER DEVELOPMENT	20
5.3 CODE	21
CONCLUSION	30
REFERENCES	31

## **DECLARATION BY THE SCHOLAR**

I hereby declare that the work reported in the B-Tech thesis entitled “**ALCOHOL DETECTION WITH ENGINE LOCKING**” submitted at **Jaypee University of Information Technology, Solan, India**, is an authentic record of my work carried out under the supervision of **Dr. Shweta Pandit**. I have not submitted this work elsewhere for any other degree or diploma.

DIVESH KUMAR

APOORV UPADHYAY

ANSHUMAN THAKUR

Department of Electronics and Communication Engineering

Jaypee University of Information Technology, Wagnaghat, India

Date: MAY, 2019.



## JAYPEE UNIVERSITY OF INFORMATION TECHNOLOGY

(Established by H.P. State Legislative vide Act No. 14 of 2002)  
P.O. Wagnaghat, Teh. Kandaghat, Distt. Solan - 173234 (H.P.) INDIA  
Website: [www.juit.ac.in](http://www.juit.ac.in)  
Phone No. (91) 01792-257999  
Fax: +91-01792-245362

### CERTIFICATE

This is to certify that the work reported in the B.Tech project report entitled “**ALCOHOL DETECTION WITH ENGINE LOCKING**” which is being submitted by **Divesh Kumar(151029), Apoorv Upadhyay(151108) and Anshuman Thakur(151094)** in fulfillment for the award of Bachelor of Technology in Electronics and Communication Engineering by the Jaypee University of Information Technology is the record of candidate’s own work carried out by him/her under my supervision. This work is original and has not been submitted partially or fully anywhere else for any other degree or diploma.

**Dr. Shweta Pandit**

Assistant Professor (Senior Grade)  
Department of Electronics & Communication Engineering  
Jaypee University of Information Technology, Wagnaghat.

## **ACKNOWLEDGMENT**

We take this opportunity to express our gratitude to our supervisor **Dr. Shweta Pandit**, for her insightful advice, motivating suggestions, invaluable guidance, help and support in successful completion of this project and also for her constant encouragement and advice throughout our Bachelor's program.

The in-house facilities provided by the department throughout the Bachelor's program are also equally acknowledgeable. We would like to convey our thanks to the teaching and non-teaching staff of the Department of Electronics and Communication Engineering for their invaluable help and support.

Divesh Kumar  
151029

Apoorv Upadhyay  
151108

Anshuman Thakur  
151094

## LIST OF FIGURES

<b>Figure</b>	<b>Caption</b>	<b>Page No.</b>
2.1	Arduino Uno	4
2.2	Arduino Uno Pin Diagram	6
2.3	Arduino Uno Power System	7
2.4	Ultrasonic Sensor	8
2.5	MQ-3 Sensor	11
2.6	Buzzer	13
2.7	DC Motor	14
2.8	SIM900A	15
2.9	LED	16
2.10	Image of whole System Design (1)	28
2.11	Image of whole System Design (2)	28
2.12	Image of Whole System Design (3)	29

## **ABSTRACT**

This project presents the design and implementation of an Alcohol Detection with Engine Locking for cars using the Ultrasonic Sensor and Arduino UNO as the MCU (Master Control Unit). The system will continuously monitor level of alcohol concentration in alcohol detection sensor and thus turn off the engine of vehicle if the alcohol concentration is above threshold level. The model will also send the message of whereabouts of the vehicle through SIM900A. The project provides an efficient solution to control accidents due to drunk driving.

### **Keywords**

Arduino UNO, MQ-3 Sensor, Ultrasonic sensor, Buzzer, LED, SIM900A, DC Motor.

# CHAPTER 1

## INTRODUCTION

The current scenario shows that the most of the road accidents are occurring due to drunk-driving. The drivers who drink alcohol are not in an stable condition and so, rash driving occurs on highway which can be risky to the lives of the people on road, the driver inclusive. The enormity of the dangerous driving transcends boundary. The laws in India are currently prohibiting drivers to drink and drive so that the fine can stop them to drink and drive. Whatsoever, effective observation of inebriated drivers could be a challenge to the policemen and road safety officers, the rationale for this stems from the natural inability of citizenry to be present additionally as state among identical house and time. This restricted ability of enforcement agents undermines each manual effort geared toward edge drink-driving. There is therefore the need for an alcohol detection system that can function without the restriction of space and time.

The Indian Ministry of Statistics reported thousands of road accidents in 2016. Though the report declared speed violation is the foremost reason for these accidents, it will safely be inferred that almost all of the cases are because of driver's unstable condition caused by drivers becoming drunk before they drive. The investigation done by the Planet Health Organization in 2008 shows that concerning 50%-60% of traffic accidents square measure associated with drink-driving. Moreover, WHO information on road traffic deaths disclosed 1.25 million traffic deaths were recorded globally in 2013 with the low- and middle-income countries having higher fatality rates per a 100K population (24.1% and 18.4% respectively), information collected showed that several of economic vehicles drivers in Bharat admitted to drinking alcohol throughout operating days. This shows that almost all drivers, particularly business and serious duty trucks drivers interact in drink-driving, which may result in accident. Bharat sets a legal limit of 30mg/100mL blood alcohol concentration (BAC), any level higher than that's same to be ineligible. The BAC depicts the amount of alcohol in an exceedingly sure volume of blood. It's measured as either grams of alcohol per metric capacity unit of blood or



milliliters of blood, (mg/ml, utilized in a lot of of Europe). For BAC level from 0.4 to 0.6, drivers feel dazed/confused or otherwise disoriented, and it's typically not safe for a driver to drive a vehicle beneath such condition. Also, BAC level for 0.7 to 0.8 makes a driver's mental, physical and sensory functions to be severely impaired. At this stage, a driver is inactive and incapable of driving. BAC level of 0.2 to 0.3 continues to be not safe however the motive force still. So, there is need of such system which can reduce the number of road accidents caused due to drunk driving.

## CHAPTER -2

### COMPONENTS USED

#### 2.1 Arduino Uno:



**Figure 2.1:** Arduino Uno

#### Specifications:

- It is based on Atmega 32 MCU
- It operates on 5v
- Permissible input volt. limit is 7-12v
- Max. permissible input volt. is 6-20v
- DC current supplied to each input\output pin is 20mA
- DC current supplied to each 3.3v pin is 50mA
- Has a flash memory of 32KB
- Has a SRAM with 2KB memory
- Has a EEPROM with 1KB memory
- Has a clock frequency of 16MHz

Arduino Uno is micro-controller development board that works on Atmega-328P. The arduino results to numerous various functions like Microcontroller area unit, computer circuit unit, primarily little computers that will run tiny easy software package programs, the area unit are enough low steam-powered which can steampowered by various batteries for years however area unit ready to measure information much quicker than a person's brain can method/suppose.

The Board is an organization in the Italy which structures and sell-circuit sheets which make micro-controller simple to utilize, they coined those circuit sheets arduino and there will be a variety kinds of arduino, those can be utilized through variety of ways and has diverse usefulness of unique applications of instance we had straightforward arduinos sheets which seems like arduino-uno which can be conservative/very useful for each task.

Arduino-uno will be utilized for various things, for example, to help engines, cameras, or can be assembled a straightforward automated framework. At that point arduinos which can have all the most dominant processors. There can be a language that gives you a chance to design arduino all equipment items similarly. Arduino uno utilizes a progression of micro-controllers the Atmega AVR they are made by organization Atmel that can be purchased in parts at that point gather on sheets which is a significant bulky undertaking.

## **PINOUT OF ARDUINO:**

Arduino-Uno relies in AVR micro-controller implied as Atmega328. The micro-controller goes with dealt with deals and many fundamental pins. ADC is used to check these pins. A 16 uber cycle for each second recurrent repeat beneficial stone generator which is set up on the board. Following figure demonstrates the pinout of the Arduino Uno Board. Check the figure:

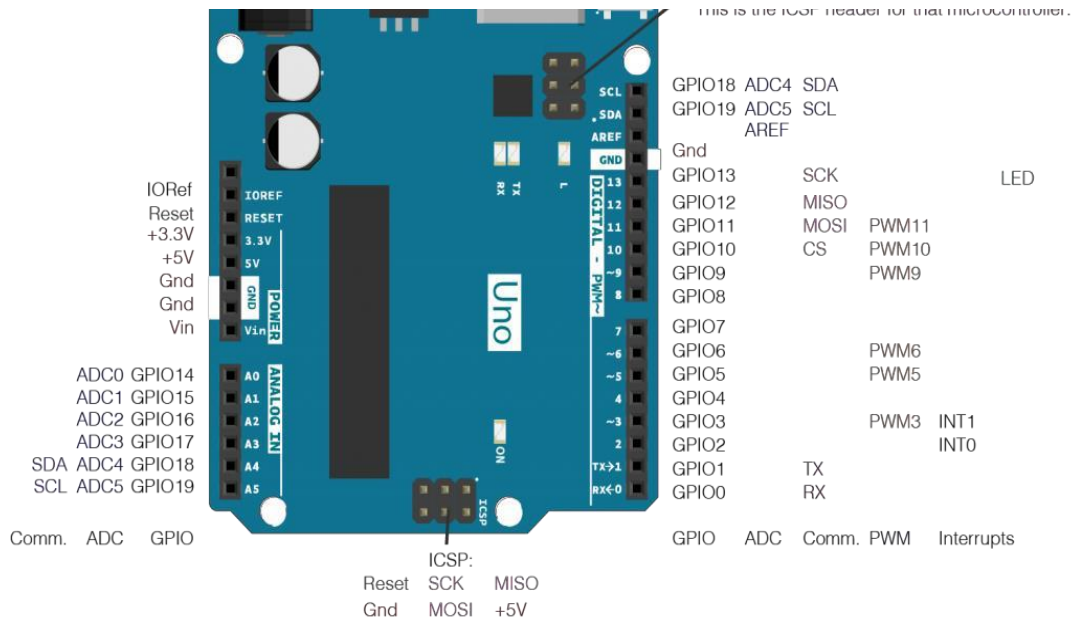

**Figure 2.2:** Arduino Uno pin diagram

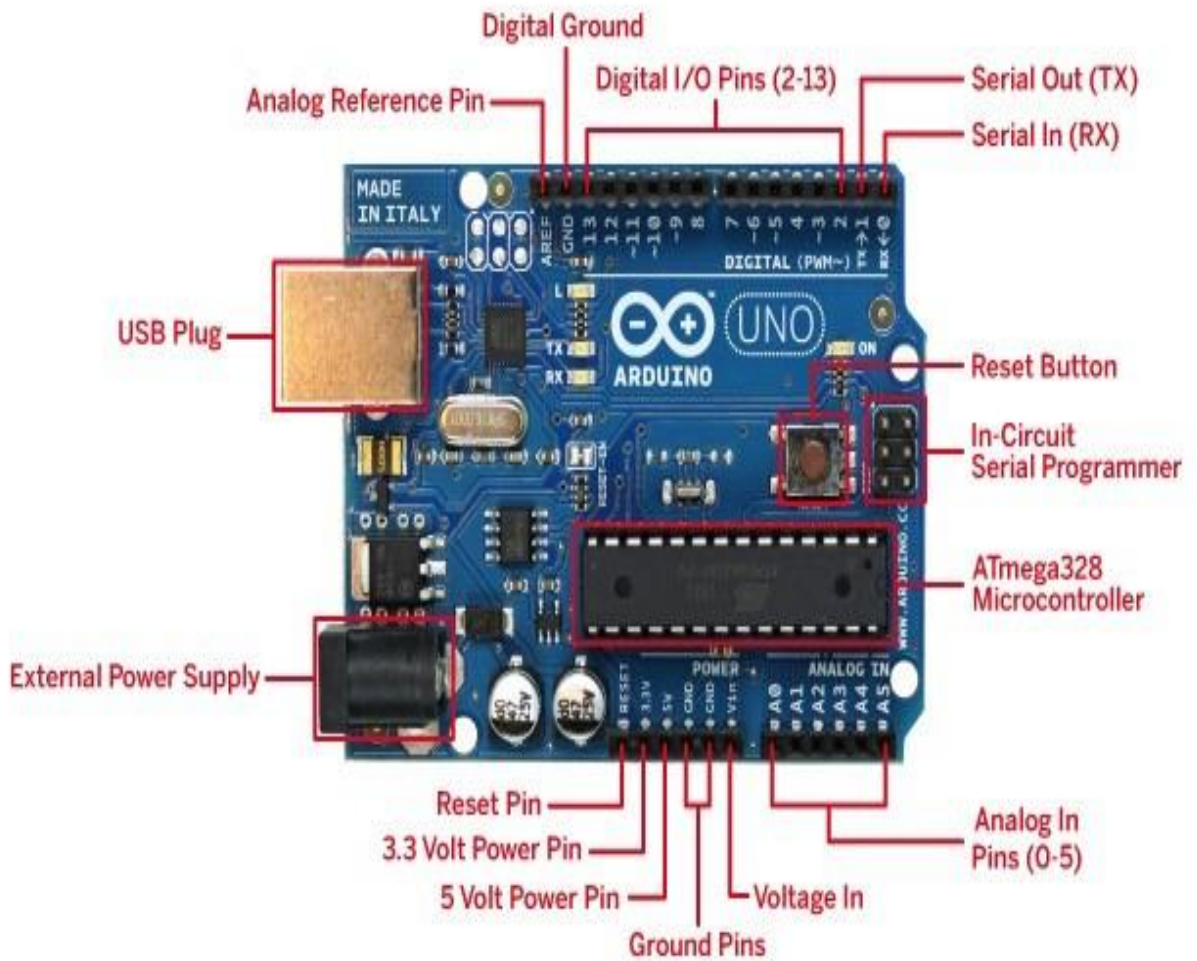
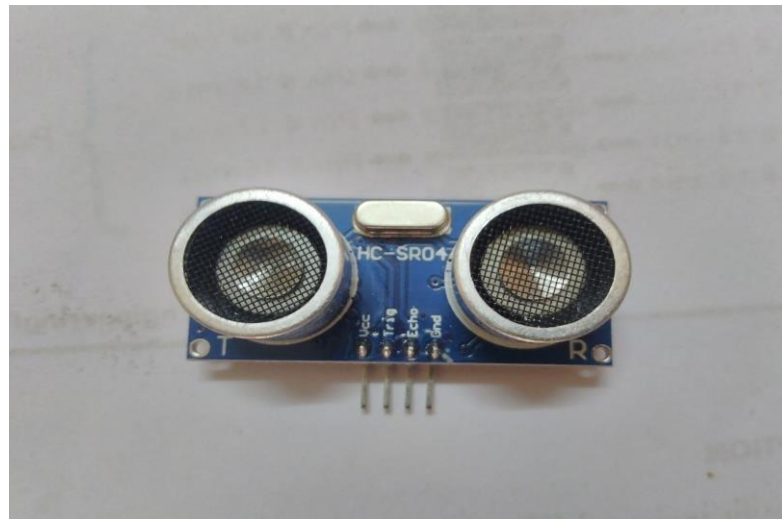

Figure 2.3: Arduino Uno Power System

## 2.2 Ultrasonic Sensor:



**Figure 2.4:** Ultrasonic Sensor

The sensor utilizes ultrasonic-sound for gauging the separation among itself/closer strong item thus it moves toward becoming stape in apply autonomy ventures. It comprise of two ultrasonic transducer one is utilized as transmitter and different as beneficiary. Ordinarily transmitter sends arrangement of ultrasonic heartbeats these are not get by collector because of it's closeness in light of the fact that ultrasonic sign are directional in any case if surface is before gadget it will reflect to it's beneficiary.

### PINOUT:

Pin Number	Pin Name	Description
1	Vcc	The Vcc pin powers the sensor, typically with +5V
2	Trigger	Trigger pin is an Input pin. This pin has to be kept high for 10us to initialize measurement by sending US wave.
3	Echo	Echo pin is an Output pin. This pin goes high for a period of time which will be equal to the time taken for the US wave to return back to the sensor.
4	Ground	This pin is connected to the Ground of the system.

**Table 2.1:** Pin Functions of an Ultrasonic Sensor

## WORKING:

To work gadget the stick is given a 5 volt 10uS heartbeat then gadget gives 8 ultrasonic (40Khz) beats. Presently the reverberation stick yields a beat of 150us to 25 ms and that beat is utilized to compute separation and it will yield beat at 38ms if there is no distinguished item.

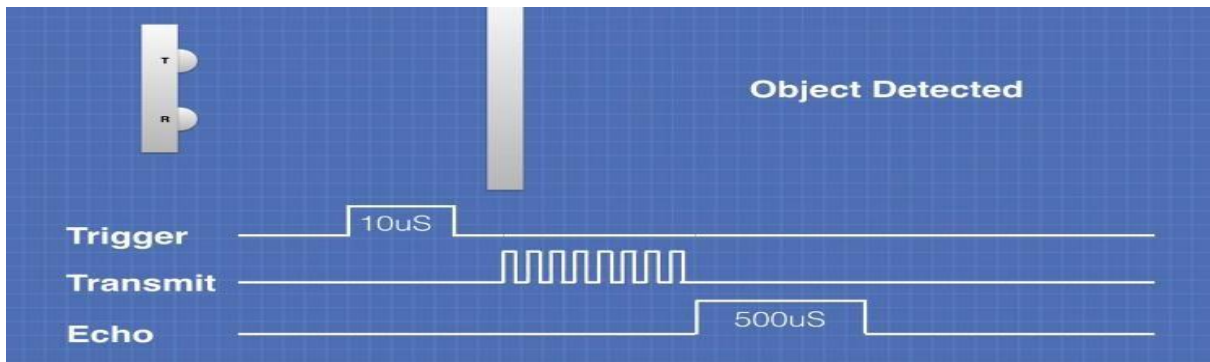

**Graph 2.1:** Ultrasonic Sensor Object Detection

### **2.2.1 Features**

The accompanying rundown indicates regular qualities empowered by the identification framework. Straightforward article recognizable: Since ultrasonic waves can reflect off a glass or fluid surface and return to the sensor, even translucent items can be identified.

Impervious to fog and soil: Observation is impenetrable to aggregation of residue or earth. Complex formed articles discernible: Detection is steady notwithstanding for targets, for example, work plate or springs.

### **2.2.2 Specifications**

- Working volt. : +5V DC
- Range measured theoretically: 2cm to 400cm
- Range measured practically: 2cm to 100cm
- Accurate level: 3mm
- The covered angle:  $\leq 15$  degree
- Operated Cur. :  $\leq 15$ mA
- Working Freq.: 40Hz
- Triggering Signal: 10us pulse
- Dimensions: 45\*20\*15mm

### **Applications:**

- Uses the facts to keep up with a vital distance and distinguish obstacles with robotic controls like biped robotic controls, way finding robotic controls etc.
- Uses to measure the division around a width of extension of 2cm to 400cm.
- Can be useful to plot the apparatus including the sensors through rotating it.
- The significance of explicit spots like wells, pits, etc can be evaluated as the waves of water can be entered.



## 2.3 MQ-3 Sensor:

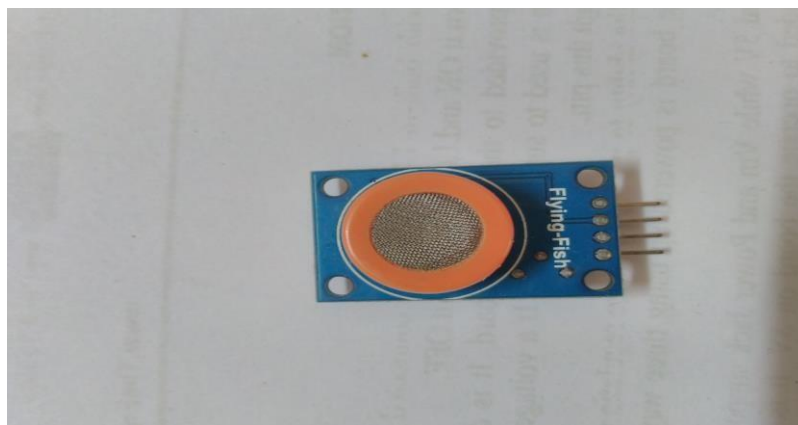

**Figure 2.5:** MQ-3 Sensor

The MQ-3 sensor is made of Tin Dioxide ( $\text{SnO}_2$ ) delicate layer. It is sorted out in such a structure to give high affectability to liquor and low affectability to Benzene. It has an immediate drive circuit to give lively reaction, quality, and longer lifetime. It is having a clear interface type. On the sensor, port pins 1, 2 and 3 tends to the yield, GND and VCC independently. The particular of the sensor is depicted in table underneath.

Parameter Name	Sensor type	Detection gas	Concentration	Voltage	Load resistance ( $R_L$ )	Heater resistance ( $R_H$ )	Sensing resistance ( $R_s$ )	Slope	Temp humidity
	Semiconductor	Alcohol gas	0.04-4mg/l alcohol	$\pm 5.0V$	Adjustable	$31\Omega \pm 3\Omega$	$2K\Omega - 20K\Omega$ (in 1000ppm 0.4mg/l alcohol)	200-	$20 \pm 2$ ; $65\% \pm 5\%RH$

**Table 2.2:** MQ-3 Sensor Table

The MQ-3 sensor is used to detect the presence of alcohol level in the surrounding and give reading to Arduino which determines whether the consumption level is in limit or not.

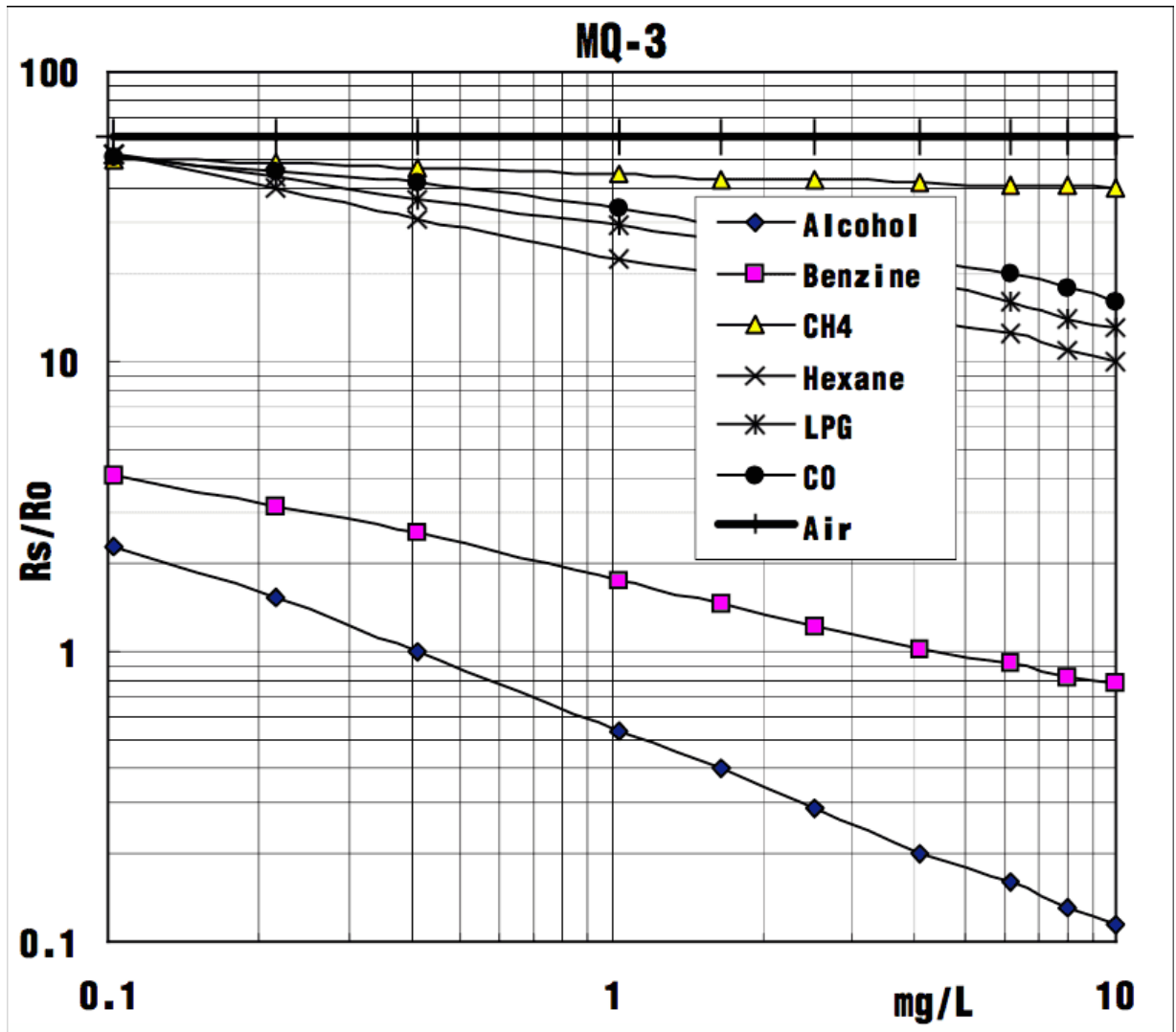

Graph 2.2: Gas Sensor Module

## 2.4 Buzzer:

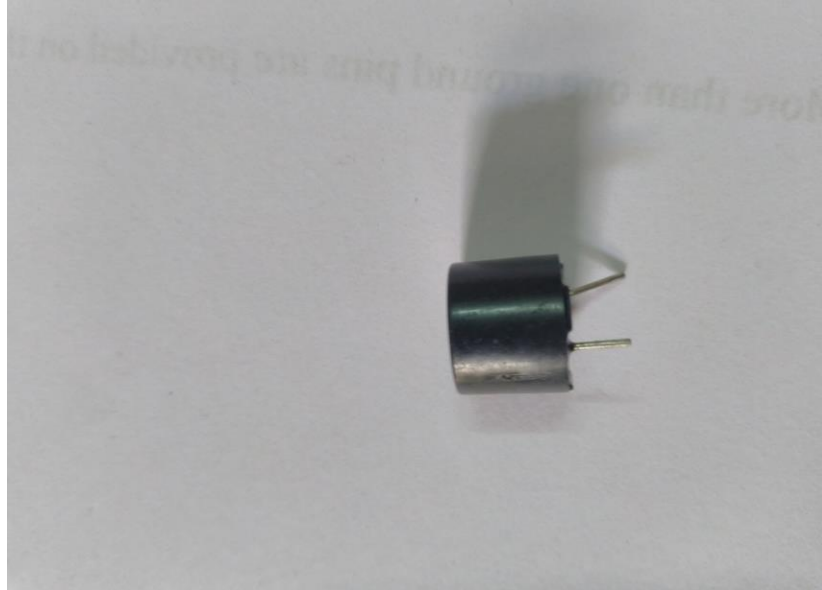

**Figure 2.6:** Buzzer

The alarm unit used is a buzzer which indicates when alcohol is detected. The buzzer is activated when an oscillating signal is passed through the coil of the buzzer and it fluctuates the disk present in the buzzer at a particular frequency which is equal to the driving signal. The buzzer indicates that vehicle in front of us is unsafe.

## 2.5 DC Motor:

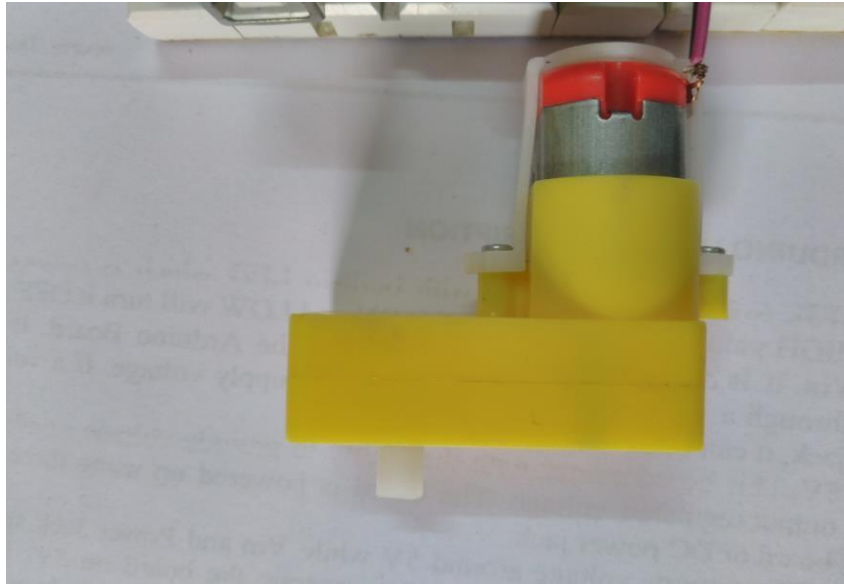

**Figure 2.7:** DC Motor

The DC motor is connected to the L293D which in turn is connected to Arduino and is given 5V supply. DC motor works on the principle of Lorentz Law. When an electric current is passed through the motor, the coil carrying the current produces magnetic field which in turn rotates the coil with the force experienced.

## 2.6 SIM900A:



**Figure 2.8:** SIM900A

This is a smaller and solid remote module structure. The SIM900A is an entire group Dual-band GSM/GPRS strategy in a SMT module which can be installed in the client applications. The SIM is embedded in the SIM900A module and the message will be sent to the cops or any specific individual that the vehicle is not safe.

## 2.7 LED:

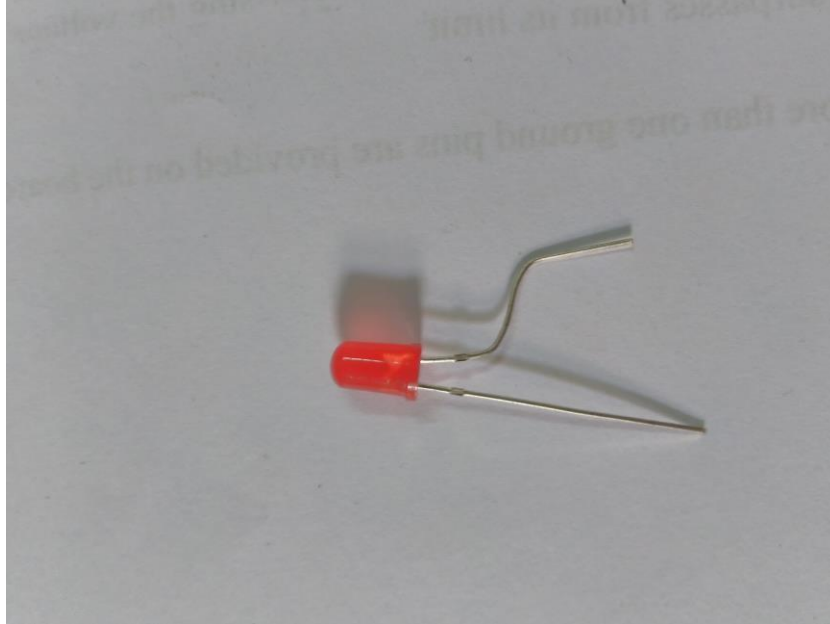

**Figure 2.9:** LED

An LED is a semiconductor light source which discharges centrality and oozes light the degree that photons when electrons join with electron openings. The shade of the light (standing out from the centrality of the photons) is compelled by the vitality required for electrons to cross the vitality band hole of the semiconductor and reach to conduction bands from the valence bands thus penetrating through energy gap.

## **CHAPTER - 3**

### **LITERATURE SURVEY**

[1] The author designs the system by using MQ-3 sensor, GPS module and the GSM module.

[3] In this paper particularly, the smart monitoring helmet has been designed by the author for alcohol detection.

[4] The paper describes the use of alcohol detection, heart rate monitoring system, personal identification system and how they can be used to avoid road accidents.

[5] Microcontroller 16F877A is used in this paper instead of Arduino.

[6] Driver's safety and the anti-theft system is discussed in this paper.

[8] In this paper, the author uses image processing to prevent accidents.

[9] Body area sensing and alcohol detection craving is used in this paper.

In our module we discussed about the alcohol detection system for vehicle using alcohol sensor, MQ-3, HC-SR04, buzzer using Arduino and send message through SIM900A.

## **CHAPTER - 4**

### **METHODOLOGY**

#### **4.1 Alcohol Detection with Engine Locking:**

The Alcohol Detection with Engine Locking system helps to reduce accidents which are occurring due to drunk driving. MQ-3 sensor detects the presence of alcohol in the surroundings. The sensor provides output on the basis of the concentration of the alcohol, if the alcohol concentration is higher the conductivity of MQ-3 sensor increases which in turn gives the reading to ARDUINO. If the reading is greater than the threshold level, ARDUINO will stop the DC motor. The red LED will also blink if the distance is less than the safe distance to give indication to other vehicles that the vehicle in front of them is unsafe. Now, with the help of SIM900A the message will be sent to the civil forces that the particular vehicle is unsafe and can be a threat to other people.



#### 4.1.1 Step-By-Step Detailed Process:

- The Arduino-Uno development board is powered by 7-12V dc supply.
- Arduino-board is used to power ultrasonic sensor.
- Arduino-board is used to power MQ-3 sensor.
- Arduino-board is used to power SIM900A.
- Alcohol concentration is determined by the help of MQ-3 sensor.
- The waves produced the ultrasonic travels at the speed of sound at 343m/s. The waves are reflected back after hitting the vehicle and the time of this process is recorded.
- This time can be calculated by measuring the separation between the sensor and the vehicle by the formulae:  $D=S*0.5*T$ .
- The Arduino is responsible for the measurement the distance between vehicles and blink the LED on the basis of that distance.
- This resulted data that is obtained will now be sent to SIM900A module.
- Further the SIM900A module is responsible for processing of this data with the help of the code and send the message.

# **CHAPTER - 5**

## **APPLICATIONS, FURTHER DEVELOPMENTS AND CODE**

### **5.1 Applications and Advantages:**

The applications of this project are easily visible.

- The Alcohol detection with engine locking system can be implemented in any 4-wheelers.
- The Alcohol detection with engine locking system can help prevent accidents due to drunk driving.
- The Alcohol detection with engine locking system can be very helpful for police.
- The Alcohol detection with engine locking system prove automatic safety system for cars and other vehicles.

### **5.2 Further development:**

There is room for improvement in this project and we'll try and aim for the same. The Alcohol detection with engine locking system can be further elaborated. We can also use the GPS module to send the location of the vehicle which is unsafe so that the police officers can reach at the desired location as quickly as possible and can prevent any further casualty

### 5.3 Code:

The code is written in C programming language.

```
int buzzer = 10;

int alcoholA0 = A5;

int motorPin1 = 6; int motorPin2 = 7;

// Your threshold value

int sensorThres = 650;

const int trigPin = 8;

const int echoPin = 9;

// defining variables

long duration;

int distance;

void setup() {

//LED

pinMode(redLed, OUTPUT);

pinMode(buzzer, OUTPUT);

//alcohol

pinMode(alcoholA0, INPUT);
```

```
//motor

pinMode(motorPin1, OUTPUT);

pinMode(motorPin2, OUTPUT);

digitalWrite(motorPin1, HIGH);

digitalWrite(motorPin2, LOW);

//ultrasonic sensor

pinMode(trigPin, OUTPUT); // Sets the trigPin as an Output

pinMode(echoPin, INPUT); // Sets the echoPin as an Input

Serial.begin(9600);

}
```

```
void loop() {  
  
    int sensorValue = analogRead(A0);  
  
    Serial.println(sensorValue);  
  
    delay(1000);  
  
    digitalWrite(trigPin, LOW);  
  
    delayMicroseconds(2);  
  
    // Sets the trigPin on HIGH state for 10 micro seconds  
  
    digitalWrite(trigPin, HIGH);  
  
    delayMicroseconds(10);  
  
    digitalWrite(trigPin, LOW);  
  
    // Reads the echoPin, returns the sound wave travel time in microseconds  
  
    duration = pulseIn(echoPin, HIGH);  
}
```

```
// Calculating the distance
distance= duration*0.034/2;

// Prints the distance on the Serial Monitor
Serial.print("Distance: ");
Serial.println(distance);

// Serial.print("Mpin1: ");

// Serial.println(analogRead(motorPin1));

// Serial.print("Mpin2: ");

// Serial.println(analogRead(motorPin2));

// Checks if it has reached the threshold value

int motor_pin1=analogRead(motorPin1);

int motor_pin2=analogRead(motorPin2);
```

```
if (sensorValue <= sensorThres && distance > 5)
{

//digitalWrite(redLed, HIGH);

tone(buzzer, 100, 20);

if (digitalRead(motorPin1) == HIGH && digitalRead(motorPin2) == LOW) {

digitalWrite(motorPin1, LOW);

digitalWrite(motorPin2, LOW);

Serial.println("AT+CMGF=1");

delay(1000); // Delay of 1000 milli seconds or 1 second

Serial.println("AT+CMGS=\"" + 917500003399 + "\"r"); // Replace x with mobile number

delay(1000);

Serial.println("far from safe distance");// The SMS text you want to send

delay(100);

Serial.println((char)26);// ASCII code of CTRL+Z

delay(1000);

}
```

```
    analogWrite(motorPin2,i);
}
digitalWrite(motorPin1, LOW);
digitalWrite(motorPin2, LOW);
tone(buzzer, 100, 20);
Serial.println("AT+CMGF=1");
delay(1000); // Delay of 1000 milli seconds or 1 second
Serial.println("AT+CMGS=\"+917500003399\""); // Replace x with mobile number
delay(1000);
Serial.println("with in safe distance"); // The SMS text you want to send
delay(50000);
Serial.println((char)26); // ASCII code of CTRL+Z
delay(1000);
```



```
}  
  
else if(sensorValue <= sensorThres && distance <5)  
{  
  
    // Code to deaccelerate  
  
    digitalWrite(redLed, HIGH);  
  
    int i=analogRead(motor_pin1);  
  
    while(i<=0){  
  
        i=i-10; Serial.print("Mpin1_value: ");  
  
        Serial.println(analogRead(motorPin1));  
  
        Serial.print("Mpin2_value: ");  
  
        Serial.println(analogRead(motorPin2));  
  
        analogWrite(motorPin1,i);  
  
        }  
    }  
}
```

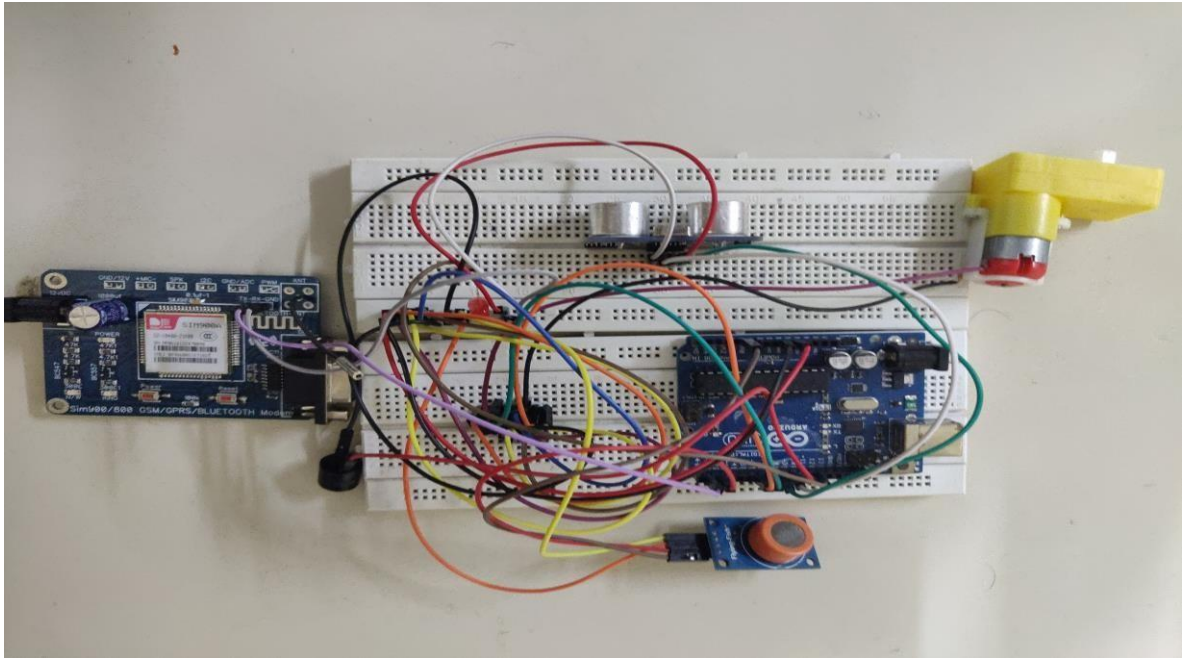

**Figure 2.10:** Image of whole system design (1)

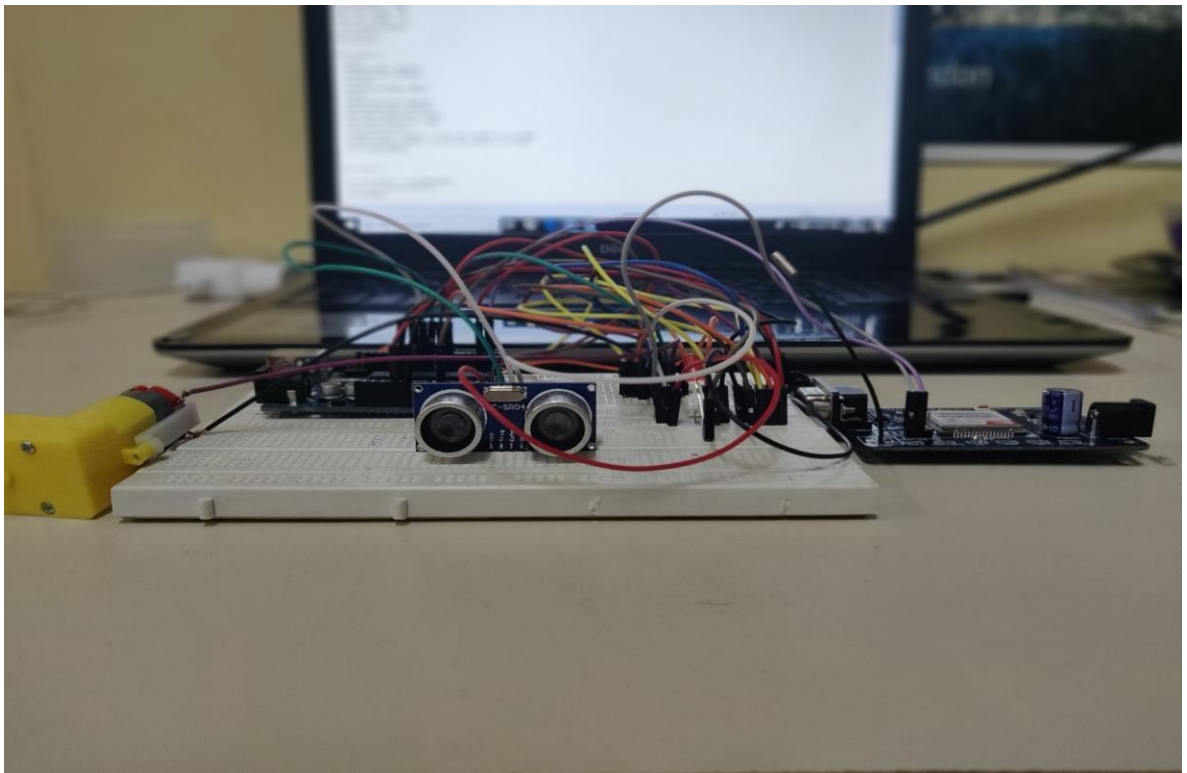

**Figure 2.11:** Image of whole system design (2)

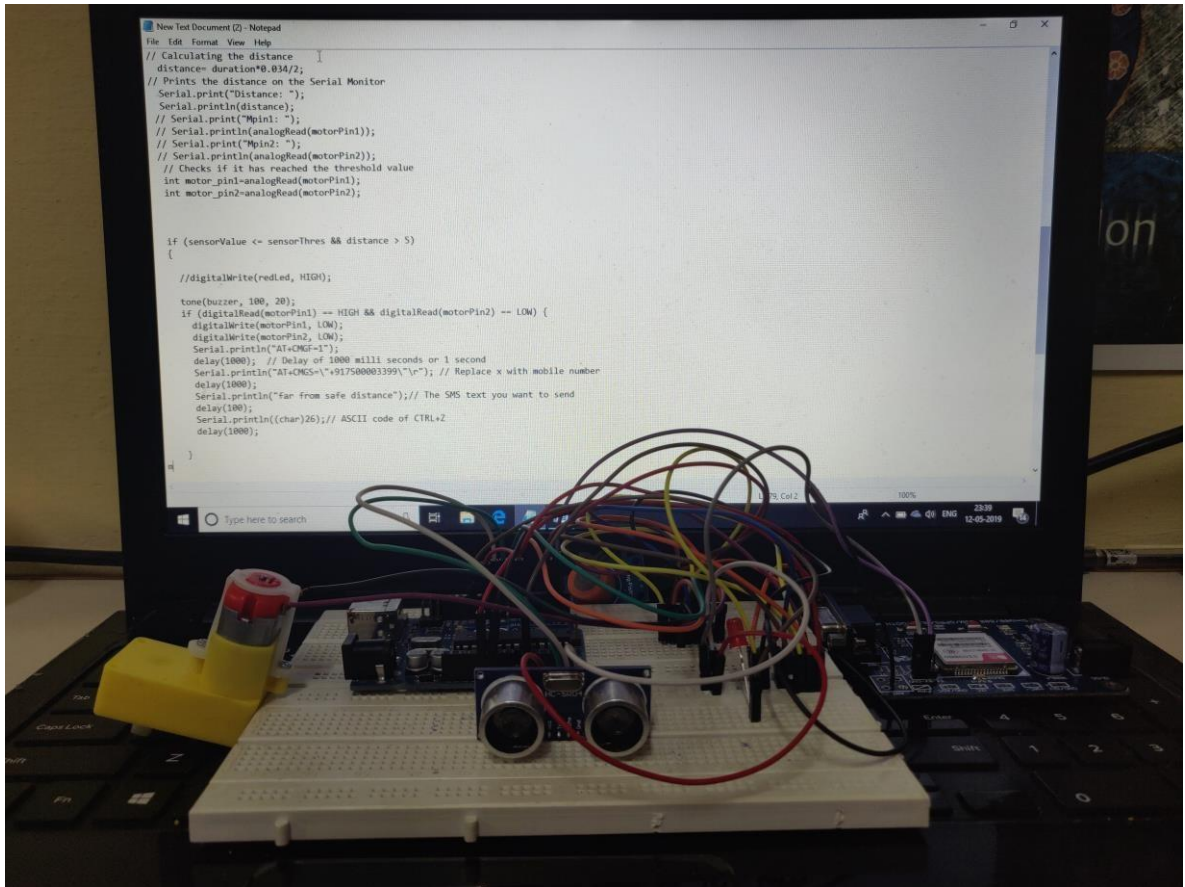

Figure 2.12: Image of whole system design (3)

## **CONCLUSION**

We have given an incredibly capable way to deal and to develop a smart system for vehicles to diminish number of disasters caused in light of alcoholic driving. As the creating insight among people is that vehicle security is dynamically critical. Future degree of this structure is to control the setbacks caused due to alcohol use. This system improves the security of individual and in this manner giving the convincing progression in the vehicle business regarding decrease setbacks caused in light of driving.

## REFERENCES

- [1] L. A. Navarro, M. A. Diño, E. Josen, R. Anacan and R. D. Cruz, "Design of Alcohol Detection System for Car Users thru Iris Recognition Pattern Using Wavelet Transform," *2016 7th International Conference on Intelligent Systems, Modelling and Simulation (ISMS)*, Bangkok, 2016, pp. 15-19.
- [2] Cahalan, D., I. Cisin, and Crossley, *American Drinking Practices: A National Study of Driving Behaviour and Attitudes*. 1969, Rutgers University Press: New Brunswick, NJ.
- [3] MUGILA.G, MUTHULAKSHMI.M, SANTHIYA.K, Prof.DHIVYA.P- SMART HELMET SYSTEM USING ALCOHOL DETECTION FOR VEHICLE PROTECTION[*International Journal of Innovative Research in Science Engineering and Technology (IJIRTSE)* ISSN: 2395-5619, Volume – 2, Issue – 7. July 2016].
- [4] Dhivya M and Kathiravan S, Dept. of ECE, Kalaingar Karunanidhi Institute of Technology- Driver Authentication and Accident Avoidance System for Vehicles[*Smart Computing Review*, vol. 5, no. 1, February 2015].
- [5] Babor, *AUDIT: The alcohol use disorders identification Test: Guidelines for use in primary health care*. 1992, Geneva, Switzerland: World Health Organization.
- [6] Lee, *Assessing the Feasibility of Vehicle-Based Sensors To Detect Alcohol Impairment*. 2010, National Highway Traffic Safety Administration: Washington, DC.
- [7] <http://www.arduino.cc/>
- [8] A. ISuge, H.Takigawa, H.Osuga, H.Soma, K.Morisaki, *Accident Vehicle Automatic Detection System By Image Processing Technology* , ©IEEE 1994 *Vehicle Navigation & ISC*.
- [9] Paul Baskett , Yi Shang , Michael V. Patterson , Timothy Trull , *Towards A System for Body-Area Sensing and Detection of Alcohol Craving and Mood Dvsregulation* , © 2013 IEEE.